

Catamaran

Maarten van Gelder

© 1987 May

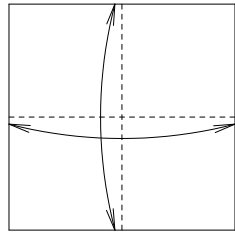

1

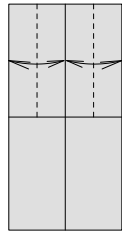

3

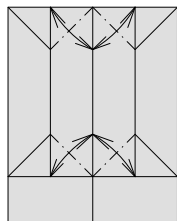

5

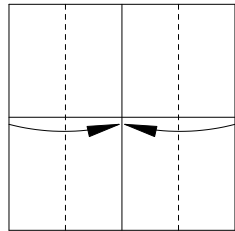

2

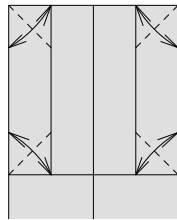

4

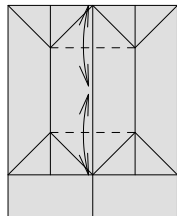

6

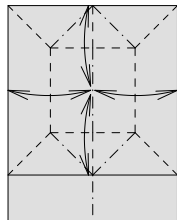

7

The right half becomes the double boat. The left half is only folded double.

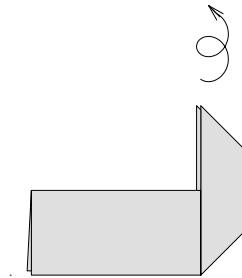

8

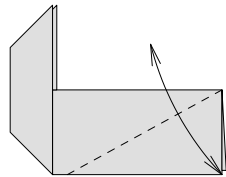

9

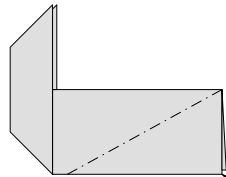

10

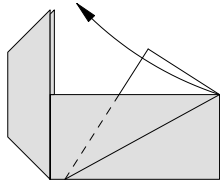

11

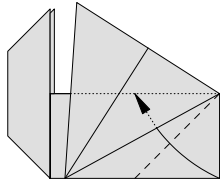

12 Fold tip of foresail between both layers.

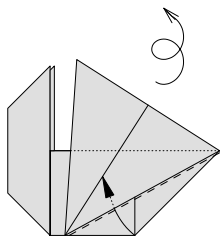

13 And again

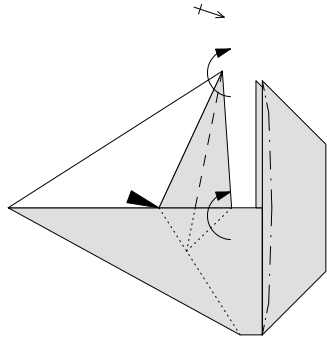

14

