

a) Begin with the frog base.

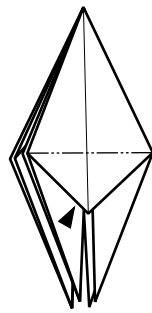

b) Tuck inside.

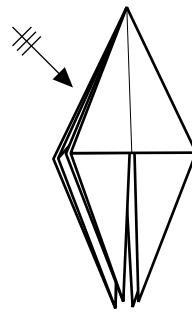

c) Repeat on other three corners.

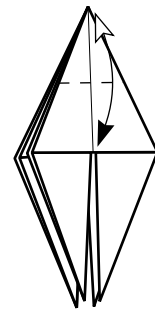

d) Make a crease.

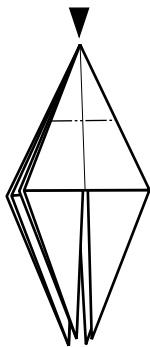

e) Sink carefully,

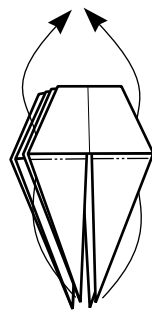

f) Reverse-folds.

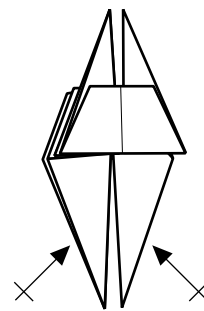

g) Repeat behind.

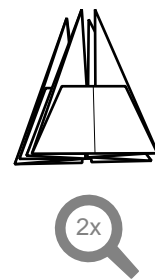

h) Double zoom.

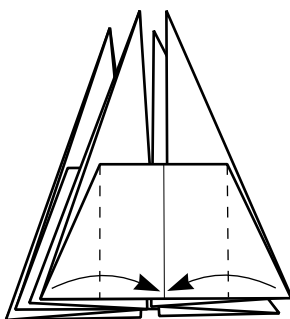

i) Fold to the center.

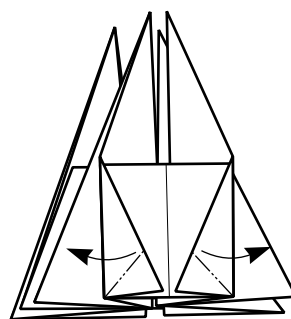

j) Squash-folds.

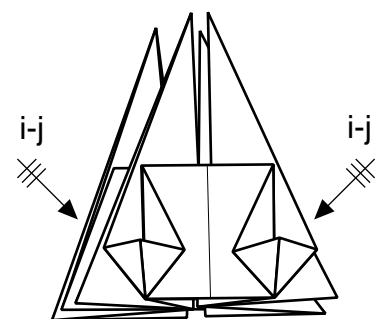

k) Repeat the last two steps on the remaining corners.

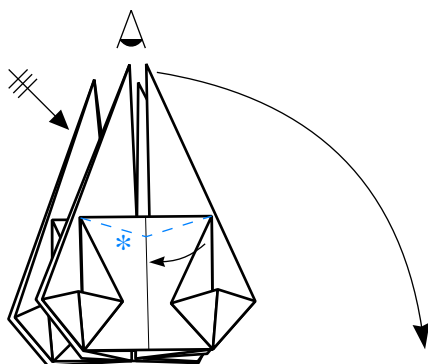

l) Open petals. Make the model to be 3D.

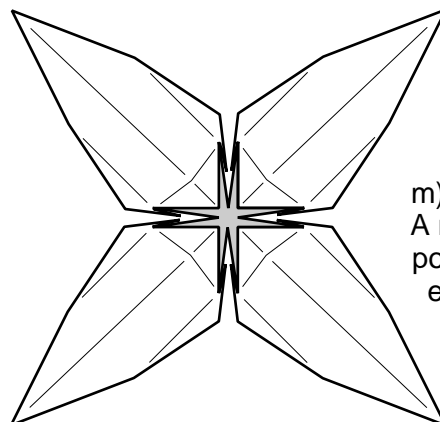

m) Ground plan. A modification is possible making eight reverse-folds (*).

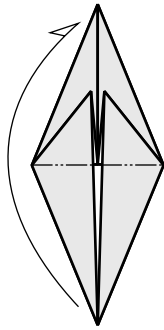

a) Begin with the fish base. Fold behind.

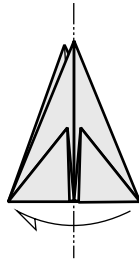

b) Fold behind.



c) Pull out the inside fold.

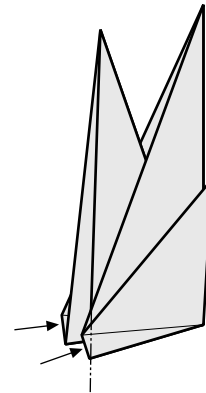

d) Fold the tips.

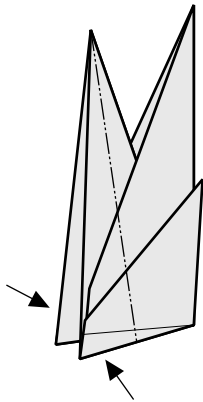

e) Fold inwards and lock together.

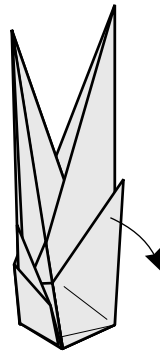

f) Shape the leaf. Repeat behind.

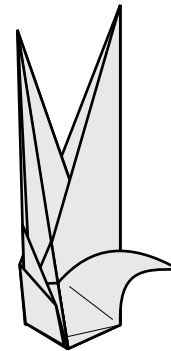

g) Fold two other stems.

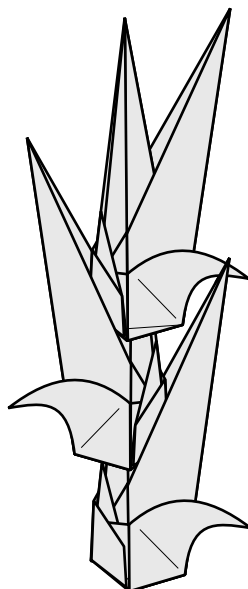

h) Put stems together and append two blooms.

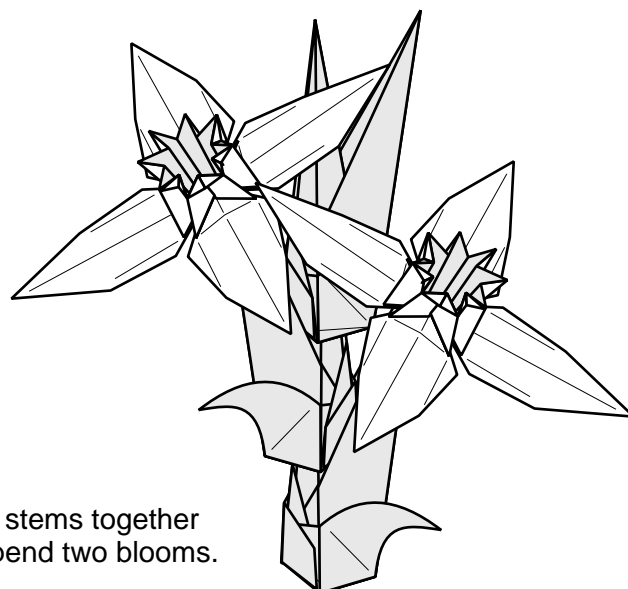

Appendix - frog base

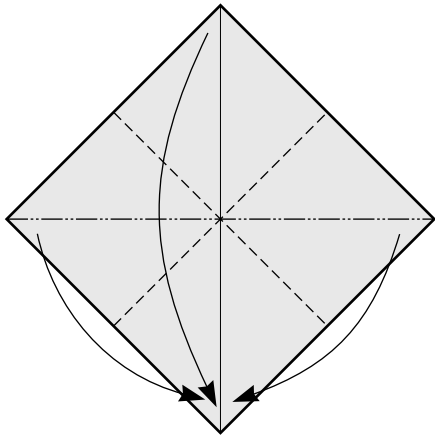

(i)

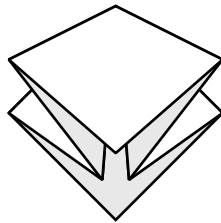

(ii)

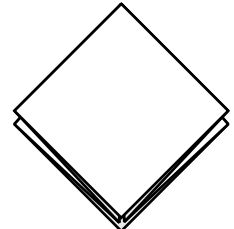

(iii) PRELIMINARY FOLD.

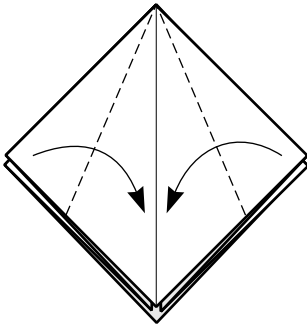

(1)

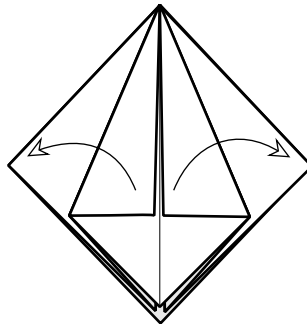

(2)

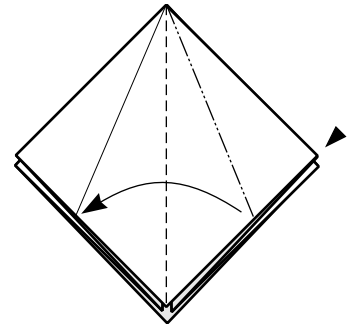

(3)

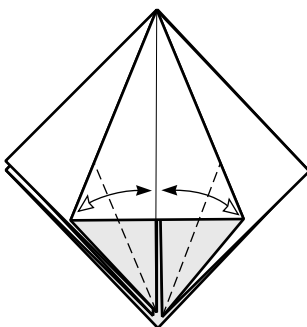

(4) Squash-fold.

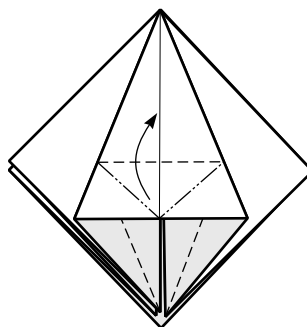

(5)

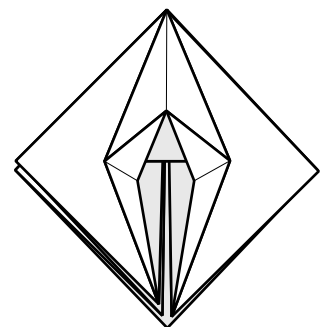

(6) Petal-fold.

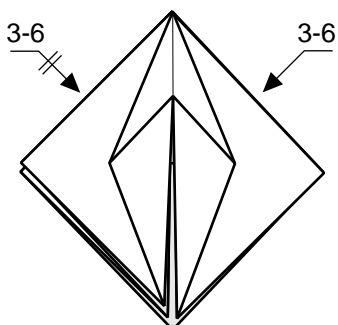

(7)

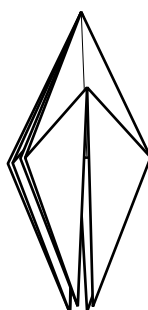

(8) FROG BASE.

Appendix - fish base

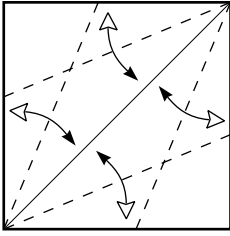

(1)

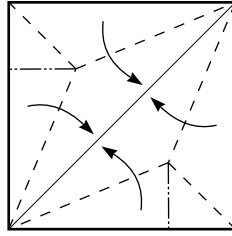

(2)

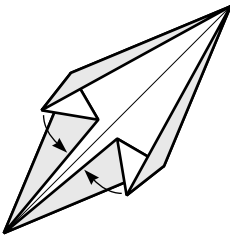

(3)

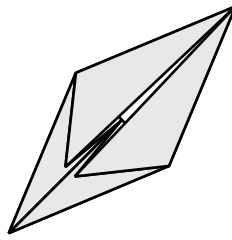

4) FISH BASE.